

# MC-618

## *Alternator Regulator*

## Installation & Operation Manual

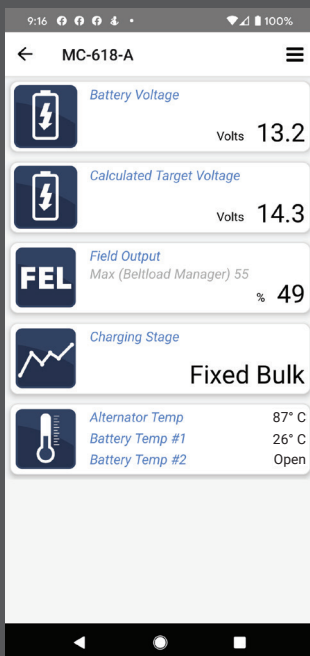

<b>Table of Contents</b>	
<b>Introduction</b>	<b>3</b>
<b>Safety Considerations</b>	<b>3</b>
<b>Regulator Installation</b>	<b>4</b>
Unpacking the Box	4
Locate And Mount The Regulator	4
Basic Wiring Installation	4
<b>Installation by Wire</b>	<b>6</b>
<b>Regulator Operation</b>	<b>10</b>
<b>Regulator Programming Methods</b>	<b>11</b>
Using the SG200 Color Display	11
Using the Bluetooth® Gateway (SG2-0300 optional) and the Balmar App	11
<b>Regulator Display Modes - Short Display / Long Display</b>	<b>13</b>
How the Magnetic Reed Switch Works	14
<b>Basic Programming with Reed Switch</b>	<b>14</b>
Programming For Battery Type	14
<b>LFP LiFePO<sub>4</sub> Recommendations</b>	<b>15</b>
<b>Regulator Programming Flow Chart (More details can be found on pages 9-14)</b>	<b>16</b>
Programming The Max Field Percentage (Belt Load Manager)	17
Programming For Short or Long Display Mode	17
Programming For Alternator Failure Advisory Mode (BDL)	17
Programming the SmartLink Device ID (dLd)	18
Programming the Battery and Alternator Temp Sensor Enforcement (SEn)	18
<b>Advanced Programming with Reed Switch</b>	<b>18</b>
Accessing The Advanced Programming Mode	18
Making Advanced Programming Adjustments	18
<b>Battery Equalization</b>	<b>20</b>
<b>Additional Regulator Features</b>	<b>21</b>
Small Engine Mode	21
Dash Lamp	21
Aux #1 Lamp	21
Force to Float	22
<b>System Troubleshooting</b>	<b>23</b>
What To Check First	23
Voltage Regulator Testing	23
Alternator Testing	24
<b>Balmar Warranty</b>	<b>25</b>

## Introduction

**The Balmar Max Charge MC-618** is the latest generation of smart, multi-stage Balmar Max Charge voltage regulators. Designed to provide precise voltage control for Balmar's high-output 12-volt alternators and other externally regulated P-type alternators, the MC-618 features user selectable programs for the following battery types: Deep cycle flooded, standard flooded, gel, AGM, spiral wound AGM, Carbon Foam and LiFePO<sub>4</sub> batteries. The regulator also features a universal default program that's designed for use in vessels utilizing voltage sensitive halogen equipment.

In addition to the user selectable preset programs, the MC-618 features a wealth of advanced programming modes which make it possible to tailor charging to a wide variety of environments.

When used in conjunction with optional MC-TS-A and MC-TS-B alternator and battery temperature sensors, the MC-618 features the ability to monitor and respond to a range of ambient temperature conditions, including reduction or discontinuation of charging voltages, should a catastrophic over-temperature condition occur at the alternator or the batteries. It can also protect Lithium batteries from being charged when the temperature falls below freezing.

When connected to an SG200 Battery monitor via SmartLink™, The following is available from the SG200's Color Display:

1. MC-618 real-time operating data
2. Battery Type selection (Basic Programming)
3. Adjustment of the Maximum Field % (Belt Load Manager)

When a SG2-0300 Bluetooth Gateway is used in conjunction with the SG200 + MC-618 even more features are unlocked via the Balmar App:

1. Real-time monitoring of the MC-618 performance
2. Full Basic and Advanced Programming from a phone or tablet
3. Save and Load program settings

## Safety Considerations

1. Always disconnect your battery banks and ensure that switches are "OFF" prior to installing your regulator.
2. Remove loose-fitting clothing or jewelry, which could become entangled in your motor or other machinery prior to installing regulator.
3. Wear ANSI-approved safety eye-wear and protective gear.
4. DO NOT attempt to modify the regulator. Modifications could result in damage to your charging system, and will void your warranty.
5. DO NOT attempt installation if you are tired or fatigued.
6. Ensure that the engine has cooled before initiating installation.
7. DO NOT attempt regulator installation while using alcohol or medication that could impair your judgment or reaction time.
8. Always use the right tool for the job. Improper tool use may damage regulator or your vessel, and could result in personal injury.
9. **Take time to read the manual. Equipment damage and possible injuries may result from an incomplete understanding of the installation and operation of the MC-618 regulator. If you are unfamiliar with electrical systems, consult with a licensed marine or mobile electrician.**

# Regulator Installation

**CAUTION:** The following instructions are intended for use by experienced electrical installers. If you are not experienced at installing electrical system components, we recommend the use of a qualified marine electrical technician.

These instructions are intended to provide the installer with the basic information required to complete installation. This section of the installation manual will deal with mounting, wiring connections and basic programming for battery type. Additional information regarding advanced programming adjustments and troubleshooting are addressed later in the manual.

## Unpacking the Box

Your Max Charge MC-618-H regulator kit is packaged with the following items:

- Max Charge MC-618 Regulator
- 54" Wiring Harness
- Fused Battery Sense Wire Pigtail
- Magnetic Programming Tool
- MC-618 Quick Start Guide

If any of the listed items are not included with your regulator kit, call our customer service department at +1-360-435-6100. Please note - If your regulator box is marked Max Charge MC-618, without the "H" designation your kit will not include the wiring harness but does include the fused battery sense pigtail.

**NOTE:** If connecting the MC-618 to a SmartLink™ network/SG200 battery monitor, a SmartLink™ Cable (Not Included) is needed. The SG2-0400 is 10 meters long, and the SG2-0403 is 5 meters in length. Both include the SG2-0404 SmartLink™ Cable Adapter

## Locate And Mount The Regulator

Choosing a mounting location for your voltage regulator should be determined based on the following factors; distance from alternator, distance from inverters, transmitters and other sources of RF noise, convenient access and readability of the display. The regulator wiring harness is 54 inches long, providing a three to four foot radius for mounting. A 120" harness is also available from Balmar (Part # 1020.) Ample airflow is essential for the regulator's proper operation. Ensure that the regulator is free from obstructions that restrict air movement around or below the regulator's aluminum heat sink. While the regulator is designed to operate safely in conditions typical of a marine engine compartment, the regulator may be better protected, and easier to use and monitor if mounted outside of the engine compartment. The max operating temperature is 90°C.

Should it be necessary to install the regulator further than >120" from the alternator, ensure that any wire extensions are properly connected, as resistance in the harness wiring can affect charging efficiency. If harness length must reach beyond approximately 10', replace the RED power and BLUE field wires with larger gauge wire that's sized to ensure voltage drop < 3%.

## Basic Wiring Installation

The regulator's wiring harness includes five wires required for standard installation. Four of those wires are connected to the regulator via a Ford-style plug connector that's preinstalled on the regulator. These wires include the Ground (BLACK), Power (RED), Ignition (BROWN), and Field (BLUE). Plug is shown at right.

In addition, the harness includes a separate Stator (WHITE) wire. This is used in some installations to provide a signal used to drive a tachometer. The proper terminal connection points for this, and additional wiring connections, are illustrated on the pin location legend shown and discussed on the following pages.

# MC-618 Regulator Terminal Layout

1. GROUND INPUT
2. POWER INPUT
3. IGNITION INPUT
4. FIELD OUTPUT
5. ALT. TEMP. (-)
6. ALT. TEMP. (+)
7. BAT. TEMP. #1 (-)
8. BAT. TEMP. #1 (+)
9. POSITIVE VOLTAGE SENSE
10. SmartLink™ TX
11. SmartLink™ RX
12. STATOR IN
13. TACHOMETER OUT
14. BAT. #2 TEMP. (-)
15. BAT. #2 TEMP. (+)
16. AUX. #1 LAMP
17. DASH LAMP

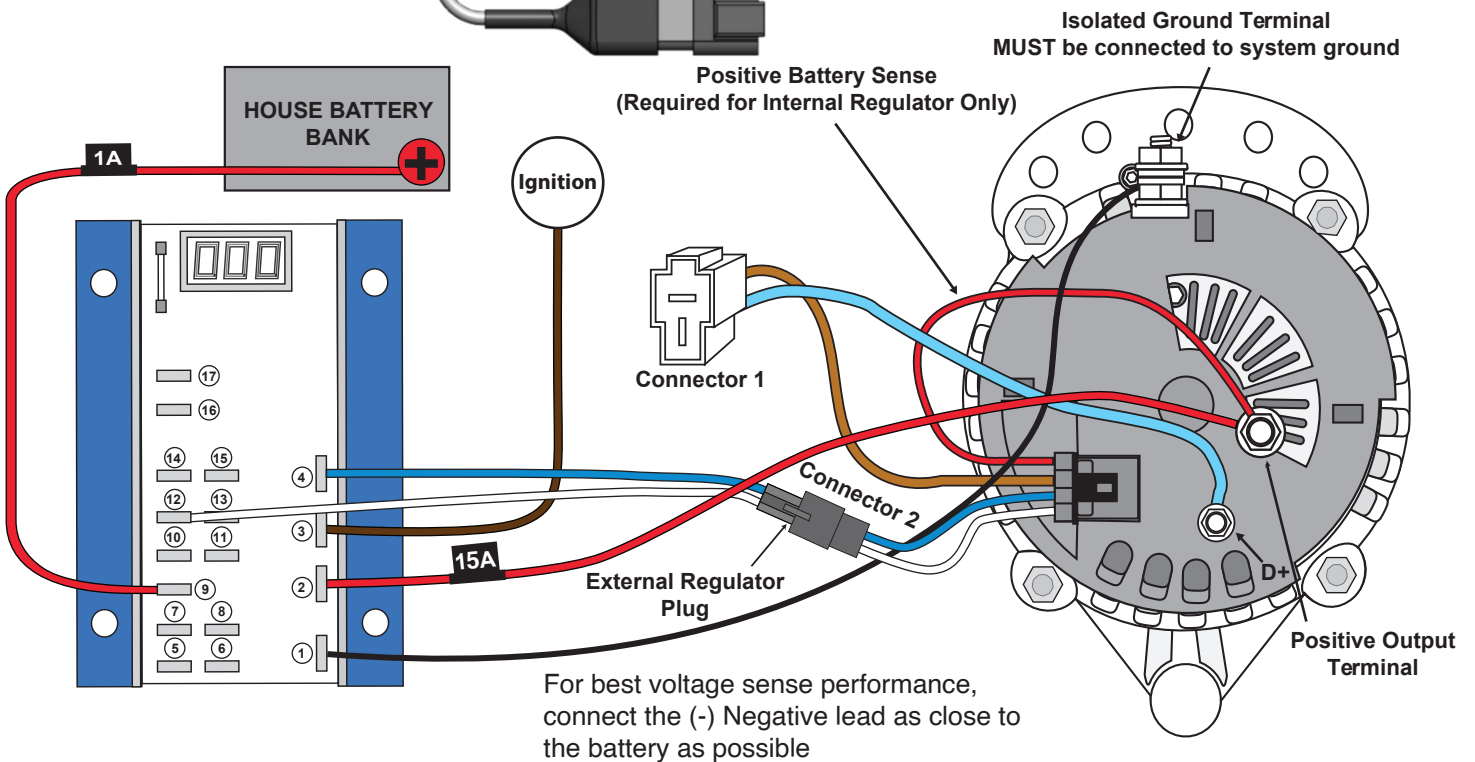
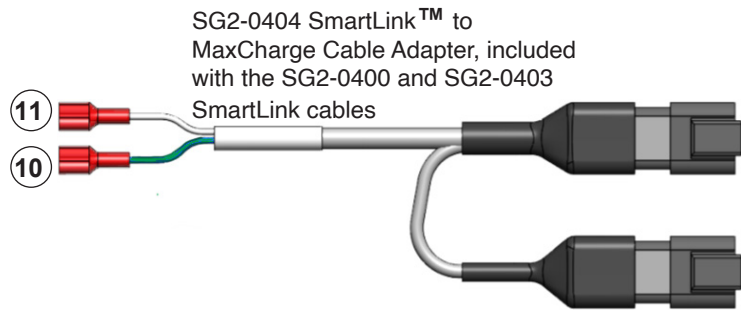
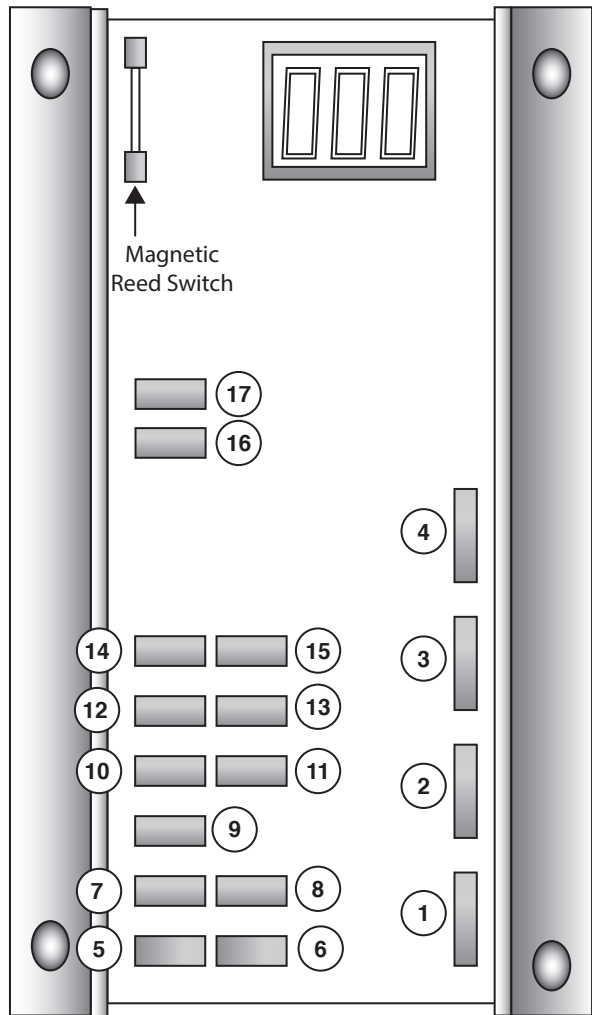

## Installation by Wire

**NOTE: Must install wires listed on this page for regulator to operate.**

### Install BLACK Ground Wire

The BLACK Ground Wire #1 in diagram at right is included in the four-wire Ford-style plug on the wiring harness and is factory installed on regulator packages designated with "H" at the end of the model number. The other end of the Ground Wire is fitted with a ring terminal connector. In some applications, this wire can be connected directly to the alternator's ground terminal post. For best accuracy ground as close to the battery as possible, especially when charging lithium batteries. Both the alternator and regulator must be connected to system ground.

### Install RED Power Wire

The RED Power Wire #2 in diagram at right is included in the four-wire Ford style plug and is factory installed on regulator packages designated with "H" at the end of the model number. The other end of the Power Wire is fitted with a ring terminal connector. In most applications, this wire can be connected directly to the alternator's positive output post. When a diode-type battery isolator is used, the power and voltage sense (#9) wires must be connected to the battery side of the battery isolator. The Power Wire is equipped with 15-amp ATC type fuse. The Power Wire must be fused to ensure against damage to the voltage regulator.

### Install BROWN Ignition Wire

The BROWN Ignition Wire #3 in diagram at right provides ON/OFF voltage for the regulator. This wire is included in the Ford-style plug at the regulator end of the wiring harness. The other end of the wire is fitted with a butt connector. Typically, the ignition wire is connected to the ON side of the ignition switch. This may be at the actual switch, or to a wire in the existing engine wiring loom that delivers switched voltage from the ignition switch. In some cases, an oil pressure switch may be used to activate the regulator. In either case, the regulator's ignition wire must see zero volts when the engine ignition is switched off.

### Install BLUE Field Wire

The BLUE Field Wire #4 in diagram at right provides regulated current to control alternator output. The wire is included in the wiring harness' Ford-style plug and is preconnected at the regulator. At the other end of the wire, you'll find either a plug or a ring terminal, depending on the alternator's field terminal connection. Attach the field wire to the alternator's field terminal.

### Install Alternator Temperature Sensor

The optional Alternator Temperature Sensors (MC-TS-A or MC-TS-A80) allows your MC-618 voltage regulator to monitor your alternator temperatures and limit output if safe operating levels are exceeded. The MC-618 uses active temperature regulation to maximize high-temperature output. The sensor includes a 54" (MC-TS-A) or 80" (MC-TS-A80) cable, a sensing attachment lug, and positive and negative regulator plug-in connectors. To install the either sensor:

1. Connect the sensor lug to one of the four bolts that hold the alternator's front and rear cases together. If a Balmar alternator is installed use the predrilled location provided on the rear case. Extend sensor cable to the regulator. The cable can be included within the regulator's wiring harness, or can be run alongside the harness and attached with cable ties.
2. Connect the temperature sensor to the Alt. Temp. terminals on the regulator. It is essential that the terminals are connected to the correct pin. Connect the red wire to the positive terminal #6 and the black wire to the negative terminal #5.

### Install Positive Sense Wire

Included with the MC-618 wiring harness kit is a fused wiring pigtail which features a ring terminal at one end and a butt connector at the other. In the center is an ATC-type fuse and fuse holder. This wire **MUST** be connected at the (#9) Positive Battery Sense Terminal. A female quick connect plug has been pre-attached on the terminal (#9) pin. To complete installation of the sense circuit:

1. Identify the favored location for battery sensing.

**NOTE: The voltage sense wire MUST be installed on the alternator side of any disconnect device. If a disconnect on the positive output cable of the alternator occurs -- such as a fuse blowing or a disconnect switch -- the sense wire must read the alternator output voltage and not the battery voltage. If the alternator is disconnected from the battery and the regulator is sensing the battery voltage, it will continue to output power, likely causing alternator damage. **This is not covered under warranty.****

2. Attach the included wiring pigtail with 1-amp fuse to a length of wire of sufficient length to reach the desired sensing location. If the length of the wire between the regulator and the sensing location is 8' or less, a 16-gauge wire is satisfactory. If the wire exceeds 8', increase the wire size to 14 gauge.
3. Remove the female 1/4" spade terminal from the terminal (#9) pin. Crimp the spade terminal to the sense wire and reconnect the spade to the (#9) pin.

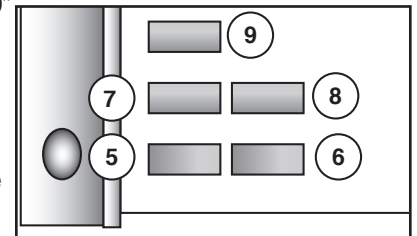
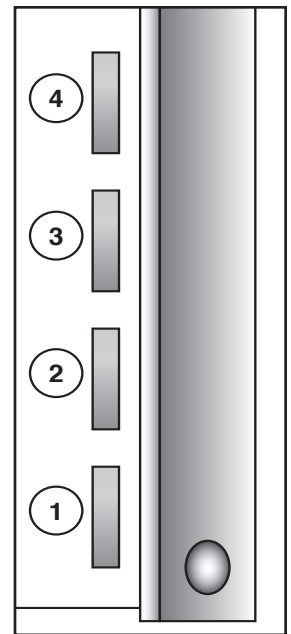



### Install Battery #1 Temperature Sensor

The optional Battery Temperature Sensor (MC-TS-B) allows your Max Charge MC-618 voltage regulator to monitor your battery bank for changes in battery temperature, adjust charging voltages to compensate for battery temperature, and respond to a battery over-or-under-temperature condition by discontinuing charging. The MC-TS-B sensor includes a 20' cable, a sensing attachment lug and positive and negative regulator plug-in connectors. To install the MC-TS-B:

4. Connect the sensor lug to the battery negative post closest to the center of the battery bank. Extend sensor cable to the regulator.
5. Connect the temperature sensor to the Bat. #1 Temp. terminals on the regulator. It is essential that the terminals are connected to the correct pin. Connect the RED wire to the positive terminal (#8) and the BLACK wire to the negative terminal (#7).

**NOTE:** Do not crush, crimp or bend the portion of the sensing lug covered by heat shrink tubing. Doing so can destroy the sensor and is not covered by warranty.

### Install WHITE Stator-In And Tach-Out Wires

When an electric tachometer is used, the alternator's stator output will provide the electrical pulse needed to drive the tachometer. The MC-618 has been designed to provide regulated tach output when the WHITE stator wire is connected to the regulator's Stator In (#12) terminal and the out feed wire to the electric tachometer is connected to the Tach Out terminal (#13) terminal. \*Not required for magnetic pick-up tachs.

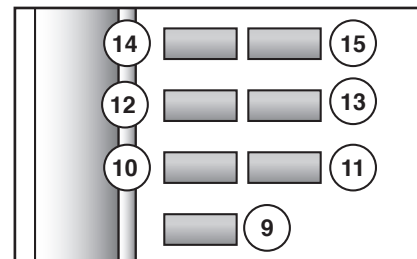

Stator output can also be used to detect alternator failure. See Page 10 for details.

When the tachometer is connected via the MC-618, the regulator will ensure that the tachometer will not discontinue supplying field current when the batteries are fully charged. When connecting the tachometer to the alternator stator output, it will be necessary to determine the number of poles in the alternator in order to properly adjust your tachometer. Most Balmar alternators feature 12-pole rotors and stators, though, in some cases, the pole count may be 14 or 16. See alternator manual for specifics. See your tachometer manual for adjustment instructions.

### Install Battery #2 Temperature Sensor

Your Max Charge MC-618 voltage regulator can accommodate a secondary battery temperature sensor. Used in conjunction with an optional MC-TS- B battery temperature sensor, the regulator can monitor temperature at a secondary battery bank and respond to a battery over-temperature condition by discontinuing charging.

To install a secondary battery temperature sensor:

1. Connect the temperature sensor to the secondary battery bank following the directions provided for the primary battery temperature sensor.
2. Connect the temperature sensor to the Bat. #2 Temp. terminals on the regulator. It is essential that the terminals are connected to the correct pin. Connect the RED wire to the positive terminal (#15) and the BLACK wire to the negative terminal (#14).

### Install Aux. 1 Lamp

The Max Charge MC-618 regulator's Aux. #1 (#16) terminal provides the ability to use a visual indicator when the regulator is operating under the following conditions: Full field (the alternator is working at full power) and Small Engine Mode (the regulator is being controlled at 50% field output). When a described condition is detected, the regulator sends the Aux. #1 terminal from neutral to ground. To utilize the Aux. #1 Lamp function:

1. Connect a small LED or incandescent lamp (maximum current flow is 500 mA) to a positive voltage source.
2. Connect the negative terminal on the lamp to the Aux. #1 terminal on the regulator.

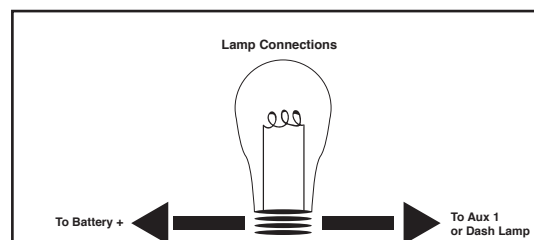

**CAUTION:** Reversing the polarity of the battery or alternator temperature sensors will damage the sensor and is not covered by warranty. Ensure that the connections are correct, and never re-connect with the regulator powered.

### Install Dash Lamp

The Max Charge Dash Lamp (#17) terminal provides the ability to activate a visual or audible indicator when the regulator monitors the following conditions: Low system voltage, high system voltage, high alternator temperature, high battery temperature (temperature conditions are only indicated when appropriate temperature sensors are connected) and no voltage on stator, indicating that the alternator has failed. When a described condition is detected, the regulator sends the Dash Lamp terminal from neutral to ground. To utilize the Dash Lamp function:

1. Connect a small LED or incandescent lamp, or an (piezo) alert (maximum current flow is 500 mA) to a positive voltage source.
2. Connect the negative terminal on the lamp or audible alert to the Dash Lamp terminal on the regulator.
3. When connected, the lamp should flash at regulator start-up to indicate active status.

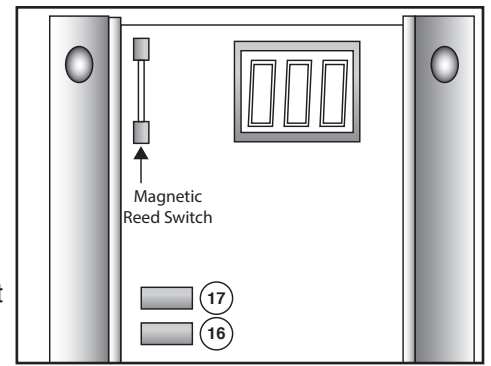

### Install SmartLink™ Adapter

If you wish to connect the MC-618 to a SmartLink™ network, this is done via the SmartLink™ Adapter, part # SG2-0404 It is included in the MC-618H kit, but not if you purchased the regulator without a harness. The two fast-on connectors shown here to the left are connected to pin 10 and 11 on the regulator. Of the two Deutsch-style connectors on the right side, only one is used in a single MC-618 installation. In all instances, it is connected to an existing SmartLink™ device using a SmartLink™ cable (SG2-0400, not included) between that device and the adapter.

**NOTE:** For more SmartLink™ installation instructions, see the SG200 Manual

**NOTE:** A Color Display CANNOT be plugged directly into the SmartLink™ adapter cable without a SmartShunt on the network. The SmartShunt is needed to power the Network. The display will not function without this power.

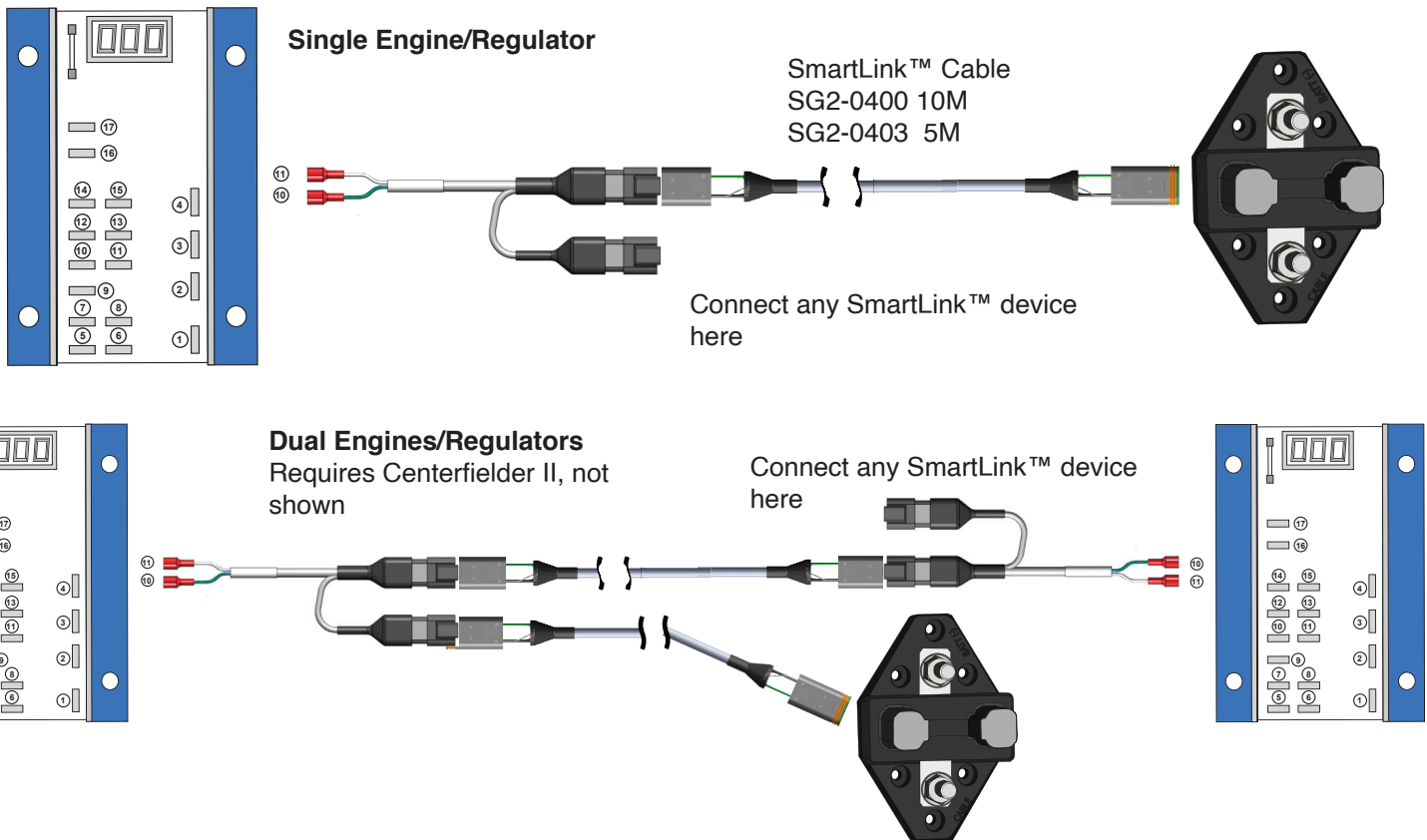

**NOTE:** When Two regulators are used on a single SmartLink™ Network, the Device ID of one regulator MUST be set to "B" See the basic programming section entitled "Programming the SmartLink™ Device ID" for more information



### **Initial Preflight Test And Start-Up**

When the regulator is properly mounted and the regulator wiring is installed, the MC-618 is ready for preflight testing. Before turning on the engine, it's advisable to check voltages at the following terminal connections to ensure that the wiring is correct. Test #1 verifies proper voltage values with the regulator turned off. Test #2 verifies the expected voltages with the regulator turned on.

Note: If the regulator's BROWN ignition wire is receiving its switched source of voltage from an oil pressure switch, it may be necessary to start the engine before applying test #2. If the engine must be run to accomplish test #2, be sure that the alternator is properly cabled on both positive and negative sides to the battery being charged. Failure to do so could result in damage to the regulator and alternator.

Using your hand-held multi-meter, test the following wiring terminals for voltage:

#### **TEST #1: Engine/Ignition Off**

- Primary RED Power Wire (Terminal #2) >12V
- Positive Voltage Sense Wire (Terminal #9) >12V
- BROWN Ignition Wire (Terminal #3) 0V
- Primary BLUE Field Wire (Terminal #4) 0V

#### **TEST #2: Engine/Ignition ON**

- Primary RED Power Wire (Terminal #2) >12V
- Positive Voltage Sense Wire (Terminal #9) >12V
- BROWN Ignition Wire (Terminal #3) >12V
- Primary BLUE Field Wire (Terminal #4) 4-12V

## Regulator Operation

The MC-618 regulator's microprocessor controlled charging system uses a sophisticated, multi-stage profile to deliver maximum charging output, while protecting the batteries from overcharging damage. When the regulator is first turned on, the processor performs a quick one-second self diagnostic assessment. Following that diagnostic, the MC-618 initiates the selected battery charge program. Note that the Factory-set default values mentioned below correspond to the UFP battery program which is enabled by default. The battery program is as follows.

1. **Start Delay.** Controls time between regulator activation and the start of charging. Factory set at one second. User adjustable with dLc (See page 14).
2. **Soft Ramp.** Gently increases target voltage from current battery resting voltage to the Bulk Charge stage target at a fixed rate of 0.04 volts per second. This stage typically takes 1-2 minutes to complete.
3. **Bulk Charge.** The most aggressive of the charging stages. Target voltage is held to a preset level for a set time period, both of which are defined by the battery program selected. As the battery charges, the voltage rises to meet and hold the Target Voltage. Factory-set values are 14.1 Volts for 0.3 hours (18 minutes), and are adjustable with bv and b1c, respectively (See page 14).
4. **Calculated Bulk Charge.** Target voltage is maintained at Bulk level. The regulator calculates battery condition by constantly monitoring field duty cycle, battery sense voltage, and an internal timer. Depending on these conditions, the regulator will stay in Calculated Bulk stage between 2 seconds and a fixed 6 hour time limit. If the 6 hour limit is exceeded it will automatically transition to the following stage. The field duty cycle target (FBA) is user adjustable. Factory set default is 65% (See page 15).
5. **Ramp to Absorption.** Gradually changes the target voltage from the current battery sense voltage to the Absorption Charge stage target at a fixed rate of 0.02 volts per 7 seconds. This stage typically takes 1 minute to complete.
6. **Absorption Charge.** The alternator output is held at a set voltage for a set time period, specified by the battery program selected. Factory-set values are 13.9 volts for 0.3 hours (18 minutes) and are adjustable with Av and A1c, respectively (See page 14).
7. **Calculated Absorption Charge.** Target voltage is maintained at the Absorption Charge level. The regulator calculates battery condition by constantly monitoring field duty cycle, battery sense voltage, and an internal timer. Once all conditions are met, the regulator will transition to the next stage. The time duration of this stage is between 2 seconds and 6 hours, depending upon battery condition. If the 6 hour limit is exceeded the regulator will automatically transition to the following stage. The field duty cycle target (FBA) is user adjustable. Factory set default is 65% (See page 15).
8. **Ramp to Float.** Gradually changes the target voltage from the current battery sense voltage to the Float Charge stage target at a fixed rate of 0.02 volts per 3 seconds. This stage typically takes about 1 minute to complete.
9. **Float Charge.** The alternator output is held at a preset voltage for a set time period, again, specified by the battery program selected. Factory-set defaults are 13.4 volts for 0.3 hours (18 minutes), adjustable with Fv and F1c, respectively (See page 14 & 15).
10. **Calculated Float Charge.** Target voltage is maintained at the Float level. The regulator can respond to an increased charge demand by reverting to the Absorption Charge stage if the conditions warrant. The battery condition is judged by constantly monitoring field duty cycle, battery sense voltage, and an internal timer. The regulator will stay in the Calculated Float charge stage a minimum of 2 seconds and up to 6 hours. If the 6 hour limit is exceeded the regulator will automatically revert to the absorption charge stage. The field duty cycle threshold (FFL) is user adjustable. Factory set default is 65% (See page 15).

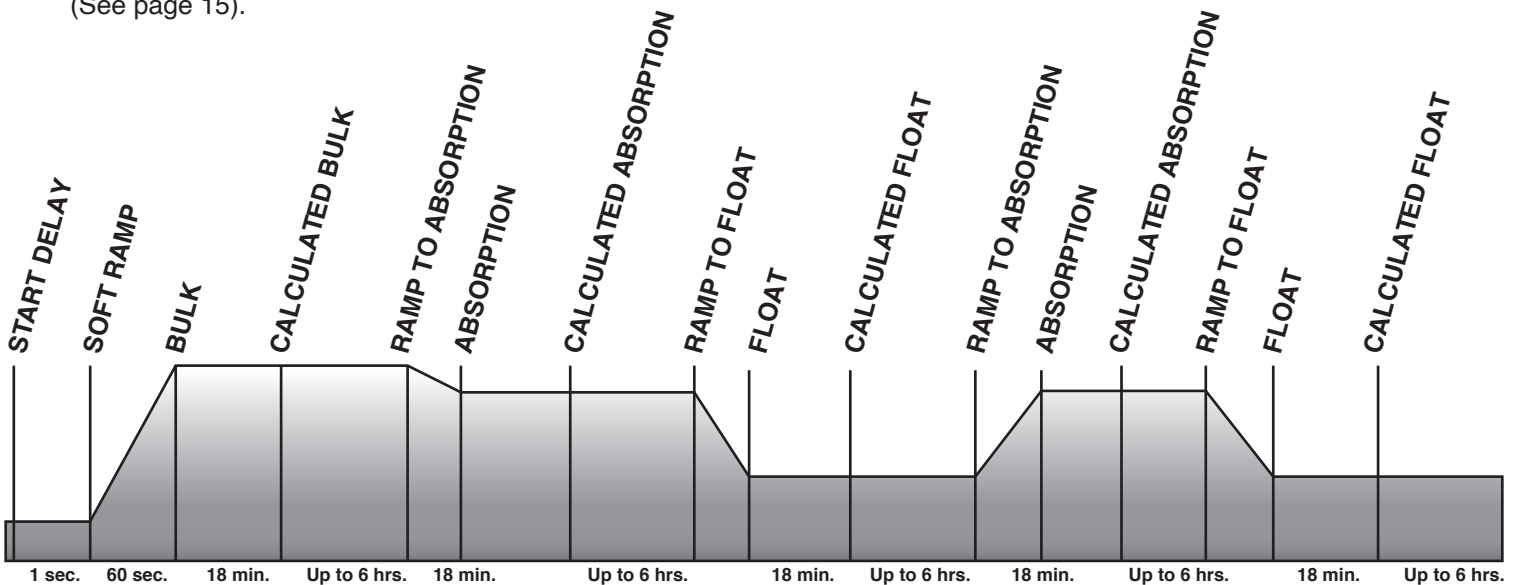

# Regulator Programming Methods

With the introduction of the MC-618, there are now three ways to program your regulator

1. Using the Magnetic Reed Switch and the Balmar Programming Tool (Magnetic Screwdriver) Just like the superseded model MC-614
2. The SG200 Color Display (Basic, but not Advanced Programming)
3. With a SG200 AND SG2-0300 Bluetooth® Gateway, you can perform Basic and Advanced Programming via the Balmar App

## Using the SG200 Color Display

When connected to the SmartLink™ Network, the Color Display of the SG200 may be used to:

1. Perform Basic programming by selecting a Battery Profile
2. Turn the Alternator Failure Advisory on/off (Shows on Regulator display only)
3. Set the regulator display to long/short mode
4. Change the Max Field Percentage of the regulator when operating. In previous regulators, this was known as Belt Manager

For more information on how to use the Color Display to change MC-618 settings, see the SG200 manual.

**NOTE:** When a battery program is changed, all settings under Advanced Settings will be replaced with the new battery program's default settings. This means that any changes to advanced settings previously made will be erased.

## Using the Bluetooth® Gateway (SG2-0300 optional) and the Balmar App

The Bluetooth® Gateway can be used to connect the Balmar App to all devices on the SmartLink™ Network. When connected to the SmartLink™ Network and the MC-618, the Balmar App may be used to:

1. Monitor the real-time performance of the MC-618 regulator
2. Perform Basic Programming by selecting a Battery Profile
3. Create, save and load Advanced Programming configurations



**NOTE:** The Bluetooth® Gateway CANNOT be connected directly to the MC-618, as the regulator cannot power the Bluetooth® Gateway. The MC-618 must be connected to a SmartLink™ network, typically a SG200 Battery Monitor.

**NOTE:** For more information on using the Balmar App to program and monitor the MC-618, please visit our website.

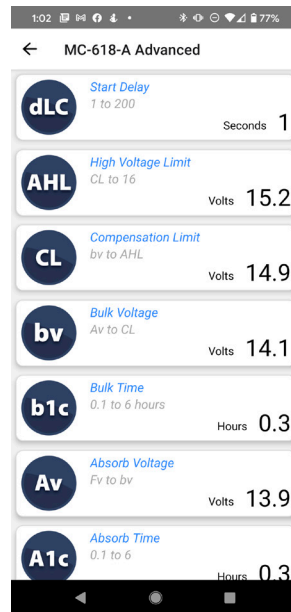
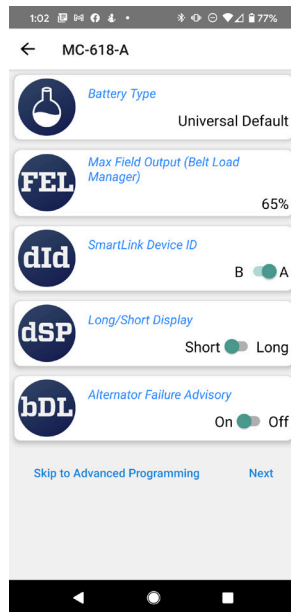
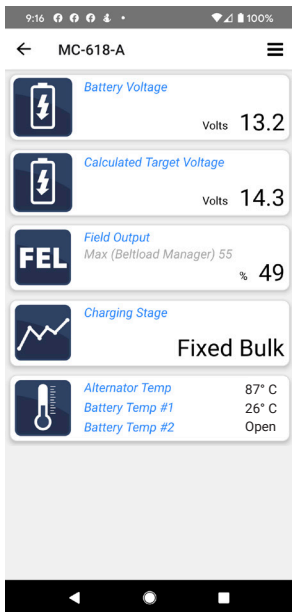











Preset, Multi-Stage Battery Programs	Balmar Regulators				Digital Duo Charge	Dual Engine Centerfielder
	12 Volt			24 Volt		
	Part Number:	ARS-5	MC-618	MC-612-DUAL	MC-624	DDC-12/24
Universal Factory Program, Deep Cycle Flooded, Gel Cell, Absorbed Glass Mat (AGM) and Spiral Wound Flooded (Optima)	Yes	Yes	Yes	Yes	Yes	Yes
Standard Flooded, Halogen Systems, Lithium	-	Yes	Yes	Yes	Yes	Yes
Carbon Foam AGM		Yes				
Balmar Alternator Models						
6-Series Alternators (70A-150A)	Yes	Yes	Yes	Yes	Yes	Yes
XT/AT-Series Alternators (165A-250A)	-	Yes	Yes	-	Yes	Yes
9-Series Large Case Alternators (140A-310A)	-	Yes	Yes	Yes	Yes	Yes
Multiple Alternator/Engine Configurations						
Dual Engine, One Alternator Each	-	Yes (qty 2)*	-	Yes (qty 2*)	Yes	Yes
Single Engine, Two Alternators	-	-	Yes	Yes (qty 2)	Yes	Yes











\*Requires a Centerfielder II, (Part # CFII-12/24)

## Regulator Display Modes - Short Display / Long Display

















The regulator's three digit alphanumeric LED display provides a scrolling view of charging status. Under normal operation, the display will indicate the following:

-  **BAL** Indicates Balmar
-  **618** Indicates Model MC-618
-  **UFP/CFP** Indicates regulator's default Universal or Custom Factory Program. Shows actual program selected.
-  **F-0** Indicates the regulator's Max Field Percentage (Belt Load Manager) . Ranges from F-0 to F-9
-  **-b-** Indicates stage of charge. "-b-" indicates bulk. "-A-" indicates absorption. "-F-" indicates float. "-r-" indicates ramp.
-  **bv** Indicates system Battery Voltage. Followed by actual voltage reading.
-  **Cv** Indicates Calculated Voltage (Target voltage based on preset program levels). Followed by voltage reading.
-  **b1** Indicates Battery #1 Temperature. Followed by NC (not connected), or temperature in Celsius.
-  **AL** Indicates Alternator #1 Temperature. Followed by NC (not connected), or temperature in Celsius.
-  **b2** Indicates Battery #2 Temperature. Followed by NC (not connected), or temperature in Celsius.

In addition to the information provided in the basic display shown above, the MC-618 long display provides the following data. The long display is accessed during basic programming, which will be discussed in the next section of the manual.

-  **FE** Indicates the percentage of field output to the alternator. The higher the percentage, the greater the output.
-  **r4.3** Indicates regulator's software revision code.
-  **SP** Indicates internal regulator temperature. Followed by degrees Celsius.
-  **SLP** Indicates, in millivolts, the value used to control voltage compensation for battery temperature.
-  **Hr.** Indicates overall regulator hours. Followed by hours and hours in hundreds of hours.
-  **FbA** Indicated field threshold from bulk to absorption. Factory set at 65%. Adjust in advanced programming mode.
-  **FFL** Indicates field threshold from float to absorption.
-  **E** Indicates System advisory codes. Individually numbered codes are defined below.
-  **dLd** Indicates the SmartLink Device ID
-  **SEn** Indicates if the Sensor Enforcement is on or off.

The following advisory codes can be used to determine possible system errors or to identify specific operational modes.. Display settings DO NOT need to be changed. See basic programming for more info.

- |  |  |  |
|--|--|--|
|  <b>E10</b> BATTERY #1 SENSOR CABLE SHORTED                 |  <b>E15</b> ALTERNATOR #1 TEMP. SENSOR CABLE OPEN OR NOT FOUND    |  <b>E25</b> - BATTERY TOO COLD. BELOW LIMIT   |
|  <b>E11</b> BATTERY #1 TEMP. SENSOR CABLE OPEN OR NOT FOUND |  <b>E20</b> BATTERY #1 TOO HOT OVER LIMIT or 55°C (Lower of two)  |  <b>E33</b> BATTERY SENSE DISCONNECTED        |
|  <b>E12</b> BATTERY #2 TEMP. SENSOR CABLE SHORTED           |  <b>E21</b> BATTERY #2 TOO HOT. OVER LIMIT or 55°C (Lower of two) |  <b>E41</b> FIELD VOLTAGE TOO HIGH            |
|  <b>E13</b> BATTERY #2 TEMP. SENSOR CABLE OPEN OR NOT FOUND |  <b>E22</b> ALTERNATOR TOO HOT. OVER LIMIT                        |  <b>E42</b> STATOR VOLTAGE TOO HIGH           |
|  <b>E14</b> ALTERNATOR #1 TEMP. SENSOR CABLE SHORTED        |  <b>E24</b> VOLTAGE REGULATOR TOO HOT. OVER 90°C                  |  <b>E51</b> SMALL ENGINE MODE IS IN OPERATION |
|  |  <b>E26</b> - DANGEROUS ALTERNATOR TEMP 150C+                     |  <b>E52</b> BELT LOAD MANAGER IS IN           |

**Note:** E codes are cumulative and will be held in memory until cleared. Codes can be cleared by entering dSP mode and letting it save.



## How the Magnetic Reed Switch Works

Looking much like a small thermometer atop the regulator's circuit board, the magnetic reed switch provides a durable, sealed interface that enables the user to set basic and advanced regulator programming features. Included with the regulator is a small screwdriver that doubles as the regulator's programming tool. A small magnet embedded in the top of the screwdriver's handle allows the user to activate the magnetic reed switch. Control of the MC-618 regulator's basic and advanced programming modes can be accessed by using this switch. The reed switch provides selectable control of the regulator's programming without creating an intrusion point as is common on many other adjustable voltage regulators currently on the market.

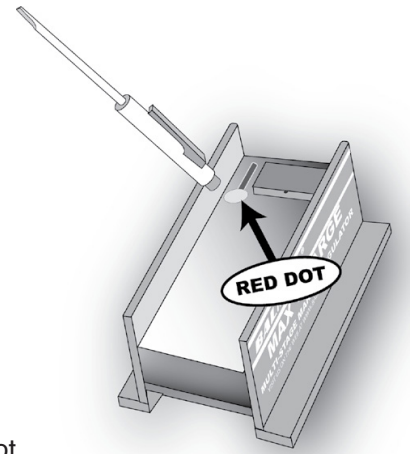

A small screwdriver with a magnet embedded in the tip of the handle is included to activate the magnetic reed switch. While any magnetic tip tool can be used, the Balmar programming screwdriver does an excellent job as an interfacing tool. By holding the magnet to the RED dot located at the end of the reed switch, the tool allows the user to scroll through the regulator's various program modes and individual program selections.

Programming is accomplished by contacting and removing the magnet from the RED dot affixed to the regulator's epoxy potting. If the magnet has difficulty activating the reed switch at that position, try moving it up and down along the length of the reed switch until the RED light is illuminated at the top of the LED display, between the second and third display digits. The RED light indicated activation of the reed switch.

Within the basic and advanced programming instructions, activation of the reed switch will be described by the following actions:

**TOUCH/RELEASE** - Indicates the action of contacting and immediately removing the magnet from the reed switch

**TOUCH/HOLD** - Indicates the action of contacting and holding the magnet to the reed switch

## Basic Programming with Reed Switch

### Programming For Battery Type

The MC-618 features selectable programs for the following battery technologies; Standard Flooded (FSb), Deep Cycle Flooded (FdC), Gel (gEL), AGM (AgL), Optima (OPS), a factory default program (UFP), a program for systems with voltage sensitive halogen equipment (HAL), and LiFePO<sub>4</sub> (LFP).

When activating the programming mode, keep in mind that the regulator will scroll through the basic programming mode three times before saving and returning to the operational mode. To adjust the regulator for your battery type:

1. Turn on the regulator. This may be accomplished by turning the ignition switch at the panel to the ON position. If the regulator's BROWN ignition wire is connected to an oil pressure switch, it may be necessary to start the engine to activate the regulator.
2. Once the regulator is on and the display is scrolling, TOUCH/HOLD the magnetic end of the programming screwdriver to the RED dot on the regulator as described above.
3. Continue to hold the magnet to the RED dot. The letters PRO will appear on the LED.
4. Continue to hold the magnet to the RED dot. The letters BA will appear on the LED.
5. Continue to hold the magnet to the RED dot. The LED display will begin to scroll through the various battery codes.
6. When the desired battery code is displayed, RELEASE the magnet from the RED dot.
7. The Display will indicate BA once again. At this point, you have the option to re-enter the battery type mode by re-applying the magnet to the RED dot. Otherwise, the display will cycle to FEL, indicating entry into the Max Field % mode.

**Pro** INDICATES ENTRY INTO BASIC PROGRAMMING MODE

**gEL** INDICATES PROGRAM FOR DEEP CYCLE GEL BATTERIES

**HAL** INDICATES PROGRAM FOR HALOGEN SYSTEMS

**bA** INDICATES ENTRY INTO BATTERY TYPE PROGRAM MODE

**AgL** INDICATES PROGRAM FOR ABSORBED GLASS MAT BATTERIES

**LFP** INDICATES PROGRAM FOR LiFePO<sub>4</sub>

**UFP** INDICATES FACTORY DEFAULT UNIVERSAL FACTORY MODE

**OPS** INDICATES PROGRAM FOR SPIRAL WOUND (OPTIMA)

**CAR** INDICATES PROGRAM FOR Carbon Foam AGM

**FdC** INDICATES PROGRAM FOR DEEP CYCLE FLOODED BATTERIES

**FSb** INDICATES PROGRAM FOR STANDARD FLOODED BATTERIES



## LFP LiFePO<sub>4</sub> Recommendations

Our LFP program is a generalized version of the recommendations provided by the top LFP battery manufacturers. For best performance and compatibility, please consult your battery manufacturer and use the regulator's advanced programming features to adjust the LFP program as needed. LFP batteries are more sensitive to abuse than a traditional chemistry battery and can fail catastrophically. It is HIGHLY recommended that the charging system as a whole be installed or inspected by a qualified marine electrical installer that has experience with Balmar charging system products and LFP batteries. The LFP profile is intended to work with the battery manufacturer's battery management systems (BMS). The LFP profile IS NOT a replacement for a BMS.



Many LiFePO<sub>4</sub> batteries have a Battery Management System (BMS) that may disconnect the battery from the alternator as a protective action or when charging is complete. The regulator must be shut down before the battery is disconnected. Running an alternator without a battery will damage the alternator and may damage any attached system. This is doubly true if the battery can be disconnected during high current charging, causing a load dump. The load dump can easily cause a high voltage spike which will destroy the alternator's rectifier, at minimum. This is not a warrantable failure. To reiterate: **THE ALTERNATOR MUST BE SHUT DOWN BEFORE DISCONNECTING THE BATTERY. THE ONLY SAFE WAY TO SHUT DOWN THE ALTERNATOR IS TO TURN OFF THE REGULATOR.** The preferred method of turning off the regulator is disconnecting the regulator's ignition (brown) wire, but if used as an EMERGENCY ONLY shutdown, disconnecting the regulator's power input (red) wire in addition to the ignition wire has a very low chance of damaging the regulator.



LFP batteries will readily accept a damaging amount of current. Applying too much charge current to a LFP battery will, at the very least, permanently damage the battery's capacity. It is CRITICAL to ensure that the alternator is not capable of exceeding the maximum continuous charge current rating of your battery (or batteries). As always, check with your battery manufacturer for specifics. Your battery manufacturer may supply you with a "C-rate" for charging and discharging. The maximum amount of charging current your battery can safely handle is determined by multiplying the "C-Rate" by the capacity of the bank. i.e. 4x 100Ah 12V batteries rated at 0.5C charge = 400 Ah \* 0.5C = 200amps MAX. If your alternator is capable of outputting more current, at any time or condition, than the battery (or batteries) can handle, you may use the Max Field % (Belt Manager) feature on the MC-618 to lower the maximum field drive output, and thereby lower the maximum alternator output current. See page 10 of your regulator manual for details and instructions. Be aware that it is not an exact 1:1 correlation between field output and alternator output, so start with more reduction (lower output) than you think you need and adjust accordingly.



It is strongly recommended that an alternator temperature sensor (MC-TS-A) be used when charging LFP batteries. Given the extremely high charge acceptance rate of LFP batteries, the alternator will be driven to full output for almost all of the charge cycle. This can cause overheating in automotive style alternators resulting in a significantly shortened lifespan. When equipped with the MC-TS-A temperature sensor, the MC-618 will help you protect your investment by performing active alternator temperature control. This is accomplished by scaling back the field voltage to the alternator when over the "AL1" temperature threshold. If you cannot use an MC-TS-A in your application, you should monitor the alternator's temperature (measure as close to the loop ends of the stator as possible) and discontinue charging if the alternator temperature rises above the maximum recommended level. You may also use the Max Field % (Belt Manager) feature on your MC-618 to reduce maximum output until a tolerable alternator temperature is maintained under all conditions.



### Battery Temp sensor

Most LFP battery manufacturers specify minimum and maximum charging temperatures to be from freezing (32°F, 0°C) to around 111°F (44°C). Again, consult with your battery manufacturer for specifics. When equipped with a MC-TS-B, the MC-618 will lower charging to a negligible amount if the battery temperature exceeds the high temperature threshold (b1H), or falls below the low temperature threshold (b1L). Charging will be re-enabled when the temperature falls within the normal range. This feature is intended to supplement, not replace, your BMS's temperature protection features. Both battery temperature thresholds (b1L and b1H) should be adjusted such that they trigger before the BMS engages in any protective actions. "B1H" should be adjusted to be slightly less than BMS's temperature high threshold. "B1L" should be adjusted to be slightly less than BMS's temperature low threshold. Be ware that an internal BMS would be measuring inside the battery, and the regulator temperature sensor outside, so there may be a difference between the two readings at any given point. The battery temp sensor will also reduce charging to very low amount if the temperature falls at or 32°F (0°C). This value is not configurable. When triggered, charging will resume when the temperature rises above 39°F (4°C).

# Regulator Programming Flow Chart (More details can be found on pages 9-14)

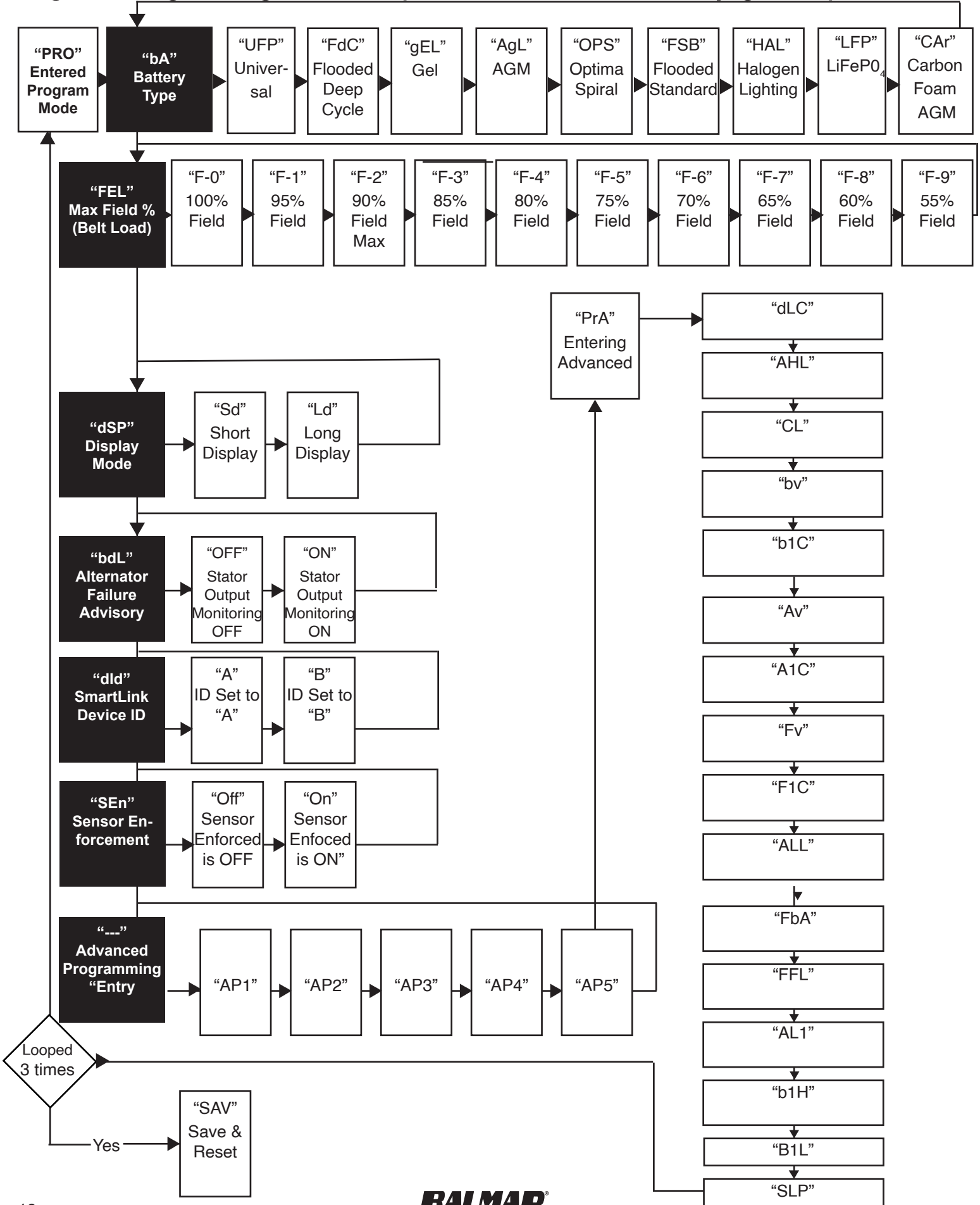

## Programming The Max Field Percentage (Belt Load Manager)

The MC-618 provides the ability to manage regulator field potential, making it possible to govern the horsepower loads placed on the drive belt(s) by the alternator. Previously known as the Belt Load Manager, the Max Field % can also be used to protect the alternator from extraordinary load created by a battery load that's too large for the alternator's capacity. The Max Field Percentage is accessed in the basic programming mode, directly after the battery type programming mode. The Belt Load Manager can be accessed at the same time the battery program is set, or by itself.

When activating the programming mode, keep in mind that the regulator will scroll through the basic programming mode three times before saving and returning to the operational mode. To adjust the regulator for your battery type:

1. Turn on the regulator. If the regulator's BROWN ignition wire is connected to an oil pressure switch, it may be necessary to start the engine to activate the regulator.
2. If the battery type program has been adjusted, TOUCH/HOLD when entry into the Max Field % is indicated by the FEL display on the regulator's LED.
3. If you don't wish to adjust the battery programming, TOUCH/HOLD the RED dot when the regulator is activated. RELEASE when the Pro display is indicated. The regulator will indicate bA, for battery type, and will cycle to FEL.
4. TOUCH/HOLD. The regulator display will indicate F-0 (indicating that the Max Field Percentage is off - or 100%). Continue to HOLD the regulator display to scroll through seven settings. Each setting decreases the field potential by approximately seven percent.
5. RELEASE when the display indicates your desired level of field reduction. The display will cycle to FEL. You can re-activate to change your selection, or wait until the regulator cycles to the next programming mode.
6. If no other changes are made to the Max Field % program, the regulator will cycle to the next programming mode.



**FEL INDICATES ENTRY INTO  
MAX FIELD % MODE**



**F-3 INDICATES FEL SETTING #3.  
FIELD REDUCTION 15%.**



**F-7 INDICATES FEL SETTING #7.  
FIELD REDUCTION 35%.**



**F-0 INDICATES FEL OFF. (Max =  
100%)**



**F-4 INDICATES FEL SETTING #4.  
FIELD REDUCTION 20%.**



**F-8 INDICATES FEL SETTING #8.  
FIELD REDUCTION 40%**



**F-1 INDICATES FEL SETTING #1.  
FIELD REDUCTION 5%.**



**F-5 INDICATES FEL SETTING #5.  
FIELD REDUCTION 25%.**



**F-9 INDICATES FEL SETTING #9.  
FIELD REDUCTION 45%**



**F-2 INDICATES FEL SETTING #2.  
FIELD REDUCTION 10%.**



**F-6 INDICATES FEL SETTING  
#6. FIELD REDUCTION 30%**

## Programming For Short or Long Display Mode

You can choose the amount of information displayed on the regulator. The information displayed on the short or long display is detailed on Page 13 of the manual. To adjust the regulator for short or long display:

1. TOUCH/HOLD when entry into the short/long display selector is indicated by dSP on the regulator's LED.
2. The regulator display will indicate codes Sd (for short display) or Ld (for long display).
3. RELEASE when the display indicates your desired display mode. The display will cycle to dSP. You can re-activate to change your selection, or wait until the regulator cycles to the next programming mode.



**dSP INDICATES ENTRY INTO SHORT  
OR LONG DISPLAY MODE**



**Sd INDICATES SHORT  
DISPLAY MODE**



**Ld INDICATES LONG  
DISPLAY MODE**

## Programming For Alternator Failure Advisory Mode (BDL)

The regulator provides a ground signal on the dash lamp terminal when the following conditions occur: low battery voltage (<12.7V), high battery voltage (>15.5V), high battery temperature (<52°C), or high alternator temperature (105°C). In addition, the user has the option to send the dash lamp ground in the event that the stator output drops to zero volts. The Regulator's Default bdL setting is ON. Monitoring stator output is an optional function which can be turned on or off in the basic programming mode. The regulator's default setting for the bdL mode is ON, meaning that the stator output is being monitored. This function can be used in conjunction with a relay to control a charge indicator lamp.

1. To enable or disable the stator monitoring function, activate and hold when the bdL mode is indicated.
2. Release when the desired setting is shown. NOTE: Stator wire must be connected to the regulator's Stator-In terminal to use this function.



**bdL INDICATES ENTRY INTO  
ALTERNATOR FAILURE  
ADVISORY MODE**



**OFF STATOR OUTPUT  
MONITORING OFF**



**ON STATOR OUTPUT  
MONITORING ON**

### Programming the SmartLink Device ID (dLd)

When shipped, the SmartLink Device ID of every MC-618 is set "A". For single regulators on a SmartLink Network, this value does not need to be changed. If two regulators are installed on a Single SmartLink network, for example in a dual-engine configuration, then the SmartLink Device ID on one of the regulators MUST be changed to B. The regulator must be in either long display mode or basic programming mode to see the dld value.

1. To change the dld value from A to B or back, activate and hold when the did mode is indicated.
2. Release when the desired setting is shown.

### Programming the Battery and Alternator Temp Sensor Enforcement (SEn)

When both Alternator and Battery Temperature sensors used and expected to be present, setting Temp Sensor enforcement to "ON" will automatically change the max field percentage when ever either sensor is missing, damaged or incorrectly connected

- If the Alternator Temperature Sensor is affected, the Max field percent is set to 50%
- If the Battery #1 Temperature Sensor is affected, the max field % is set to 12. This usually provides about 3-8A depending on the alternator and RPM.

**Note: Some regulators used as original equipment may have this feature turned on by default**

## Advanced Programming with Reed Switch

### Accessing The Advanced Programming Mode

**NOTE:** Advanced programming can be most easily performed with the Balmar APP when the MC-618 is connected to a SmartLink network with a Bluetooth gateway. The Balmar App lets you change each parameter and then see all the old and new values on one screen, where you can check for accuracy before writing the changes to the regulator.

The MC-618 provides a broad range of advanced user adjustments in it's password-protected Advanced Program Mode. The

Advanced Program mode is accessed via the Basic Program mode. To access the Advanced Program mode:

1. With the regulator activated, TOUCH/HOLD the magnet to the RED dot on the regulator's epoxy potting.
2. The regulator will cycle to PRO. RELEASE the magnet from the switch.
3. The regulator will cycle through all of the Basic Program modes; bA, bEL, dSP, and bdL followed by three dashes.
4. TOUCH/HOLD when the three dashes are displayed. The dashes will be replaced by AP0 followed by AP1, and so on.
5. When the display indicates AP5, RELEASE.
6. The display will cycle to PrA, indicating entry into the Advanced Programming mode.

 **Pro** INDICATES ENTRY INTO PROGRAM MODE

 **dSP** INDICATES SELECTION MODE FOR SHORT/LONG DISPLAY

 --- ENTRY POINT FOR ADVANCED PROGRAMMING MODE - ENGAGE MAGNET

 **bA** INDICATES SELECTION MODE FOR BATTERY TYPE

 **bdL** INDICATES ALTERNATOR FAILURE ADVISORY (BDL)

 **AP1** CONTINUES COUNTDOWN TO AP MODE

 **FEL** INDICATES SELECTION MODE FOR MAX FIELD %

 **dld** INDICATES SELECTION MODE FOR SMARTLINK DEVICE ID

 **AP5** REMOVE MAGNET TO START AP MODE

 **SEn** INDICATES SELECTION MODE FOR SENSOR ENFORCEMENT

 **PrA** INDICATES ENTRY INTO THE ADVANCED PROGRAM MODE

### Making Advanced Programming Adjustments

Once accessed, the Advanced Program mode allows the user to adjust time, voltage and temperature setting for the active battery program. Adjustments made are semi-permanent meaning they will be saved until the battery program is changed. All defaults shown below are for the UFP program and will vary depending on which program you have selected. To change the settings TOUCH/HOLD the magnet to the RED dot on the epoxy potting when the desired mode is indicated. When the reed switch is engaged, the values for the various modes will scroll upward or downward. To reverse the direction of scroll:

1. REMOVE the magnet from the reed switch.
2. Wait for the mode indicator to be displayed.
3. TOUCH/HOLD when the mode indicator is displayed. The values for that mode will begin to scroll in the opposite direction. Continue to HOLD until the desired value is displayed.
4. REMOVE the magnet from the RED dot. The mode indicator will be displayed again, followed by the indicator for the next Advanced Programming mode.

## Advanced Programming settings:



**(PrA) Advanced Program Mode.** Once the correct password is used to unlock the Advanced Program mode, the PrA display will be immediately followed by Advanced Programming modes. The Advanced Programming modes include:



**(dLc) Start Delay.** Controls time from regulator activation to start of charging. Factory preset at one second. Adjustable to a maximum of 200 seconds.



**(AHL) High Voltage Limit.** Controls high voltage alarm threshold. Adjustment spans from cl to 16 volts. Default is 15.2 volts adjustable in .1 volt increments. See information for Battery Equalization for more details on AHL adjustment.



**(CL) Compensation Limit.** Controls maximum allowable temperature compensated system voltage. Adjustment spans from bv to AHL. Default is 14.8 volts. Adjustable in .1 volt increments.



**(bv) Bulk Voltage.** Controls the target voltage for bulk charge mode. Adjustment spans from Av to cL. Default is 14.1 volts adjustable in .1 volt increments.



**(b1c) Bulk Time.** Controls minimum time in Bulk Mode before entering Calculated Bulk. Standard value set is .3 hours (18 minutes). Settings are from 6 minutes to 6 hours. Adjustable in .1 hrs (6 minute) increments.



**(Av) Absorption Voltage.** Controls the target voltage for absorption charge mode. Adjustment spans from Fv to bv. 13.9 V default, adjustable in .1 volt increments



**(A1c) Absorption Time.** Controls minimum time in Absorption Mode before entering Calculated Absorption. Standard value set is .3 hours (18 minutes). Settings are from 6 minutes to 6 hrs. Adjustable in .1 hrs (6 minute) increments.



**(Fv) Float Voltage.** Controls the target voltage for float stage. Adjustment spans from ALL to Av. Default is 13.4 volts, adjustable in .1 volt increments



**(F1c) Float Time.** Controls minimum time in Float Mode before entering Calculated Float. Standard value set is .3 hours (18 minutes). Settings are from 6 minutes to 6 hrs. Adjustable in .1 hrs (6 minute) increments.



**(ALL) Low Voltage Limit.** Allows user control of regulator's low voltage limit. Spans between 10 volts and Fv. Dropping below ALL causes Dash Lamp to turn on. Default is 12.7 volts in .1 volt increments.



**(FbA) Field Threshold - Bulk and Absorption.** Controls the field output threshold required to cycle from Bulk to Absorb and Absorb to Float. Factory set at 65% of field output. Raising "FbA" shortens calculated bulk and absorption charge time. Adjusted in 1% increments. Span of adjustment is 16% to 96%.



**(FFL) Field Threshold - Float to Absorption.** Controls the field output threshold required to cycle from float to absorption charging modes. Factory set at 65%. Raising "FFL" increases calculated float charge time. Adjusted in 1% increments. Span of adjustment is 16% to 96%.



**(AL1) Alternator Temperature Threshold.** Controls the Alternator over temperature set point. Requires MC-TS-A temperature sensor to be connected to the Alt. Temp. #1 and/or Alt. #2 temperature sensor terminals. Preset at 100°C. Spans from 60-128°C. Adjustable in 2°C increments.



**(b1L) Battery Temperature Low Threshold.** Controls the Battery under temperature set point. Requires MC-TS-B temperature sensor to be connected to the Bat. Temp. #1 terminals. Preset at 32°C. Spans from -60 to 42°C. Adjustable in 2°C increments.



**(b1H) Battery Temperature High Threshold.** Controls the Battery over temperature set point. Requires MC-TS-B temperature sensor to be connected to the Bat. Temp. #1 and or Bat. #2 temperature sensor terminals. Preset at 52°C. Spans from 42-56°C. Adjustable in 2°C increments.



**(SLP) Temperature Compensation Slope.** Adjusts the target voltage (Cv) to compensate for battery temperature. Can be adjusted to meet the needs of unique battery technologies. Consult with the battery manufacturer for specific slope recommendations. Total voltage compensation is calculated assuming a 6 cell (12V) battery. Compensation only occurs when a battery temperature sensor is installed. The adjustment range spans from 0 to 8.3 millivolts per degree Celsius, per cell. Default value is 6.0mV/°C/cell.



## Battery Equalization

Due to the potentially hazardous nature of equalization (the intentional overcharging of batteries to remove sulfation from the battery plates) we strongly recommend that the process be done at the dock with a voltage-adjustable shorepower charger. If it is absolutely impossible to do so, equalization can be done with the alternator and regulator by doing the following:

1. In Advanced programming, Pra, change the following values.
2. Cl to a voltage above the desired equalize voltage.
3. AHL to a voltage above the desired equalize voltage.
4. Bv to the desired equalize voltage.
5. Blc to the desired equalize time.
6. Disconnect ALL battery temperature sensors.
7. YOU MUST MONITOR THE BATTERIES DURING EQUALIZE PROCESS!
8. Once the equalization is complete, activate the regulator's basic programming and reset the battery program mode to UFP, and allow the program to save. Once saved, access the basic programming mode again and reset for the desired battery program.

**WARNING:** Equalization is a manual process with potential dangers. Do not leave system unattended. Check with your Battery Manufacture to see if Equalization is suggested or safe.



### Default Program Settings By Battery Type

	UFP	Fdc	gEL	AgL	OPS	FsB	HAL	LFP	CAr
START DELAY (SECS.)	1	1	1	1	1	1	1	1	1
HIGH VOLTAGE LIMIT (VOLTS)	15.2	15.6	15.1	15.4	15.6	15.4	15.0	14.8	15.4
COMPENSATION LIMIT (VOLTS)	14.8	14.8	14.8	14.8	14.8	14.8	14.8	14.8	14.8
BULK VOLTAGE	14.1	14.6	14.1	14.4	14.6	14.4	14.0	14.3	14.4
BULK TIME (MINIMUM)	18 MIN	18 MIN	18 MIN	18 MIN	18 MIN	18 MIN	18 MIN	6 MIN	18 MIN
ABSORPTION VOLTS	13.9	14.4	13.9	14.2	14.4	14.2	13.8	13.6	14.2
ABSORPTION TIME (MINIMUM)	18 MIN	18 MIN	18 MIN	18 MIN	18 MIN	18 MIN	18 MIN	18 MIN	18 MIN
FLOAT VOLTS	13.7	13.4	13.7	13.4	13.4	13.4	13.5	13.4	13.4
FLOAT TIME (MINIMUM)	18 MIN	18 MIN	18 MIN	18 MIN	18 MIN	18 MIN	18 MIN	18 MIN	18 MIN

**NOTE:** Some OE Supplied regulators may Show “CFP” instead of “UFP” This means it is a Custom Factory Program, and is the recommended and default program for your installation.

## Additional Regulator Features

### Small Engine Mode

In situations where additional power is needed for propulsion, the MC-618 provides the option to manually reduce regulator field output by approximately one half. This option, called Small Engine Mode, can be accessed by shorting the positive and negative Alternator #1 Temperature Sensor terminals. This can be done by splicing into the positive and negative wires of the Alternator Temperature Sensor cable (MC-TS-A) with a switched wire. With the switch in the OFF position, the Alternator #1 Temperature Sensor will work normally. With the switch in the ON position, the regulator will reduce field output by approximately 50%. To enable the Small Engine Mode:

1. If the Alternator Temperature Sensor cable is being used, replace the female terminal connectors on the cable with Multi-Stack Connectors (Ancor Part # 230612).
2. Install a standard ON/OFF switch in a convenient location.
3. Run wires from the switch back to the positive and negative terminals of the Alternator #1 Temperature Sensor terminals ( #5 and #6).
4. Add appropriate connectors to the switched wires and connect to the positive and negative terminal connections.

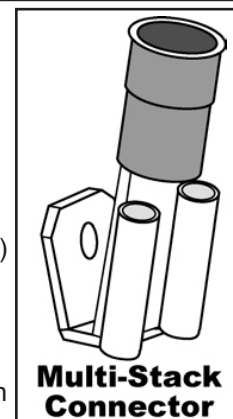

### Dash Lamp

The MC-618 provides a Dash Lamp circuit that's capable of providing a signal to a user supplied and installed audible or visual alert if the following issues were to occur while the regulator is in operation:

- Low Battery Voltage <12.8V Adjustable with “ALL.” (See Page 12)
- High Battery Voltage >15.5V Adjustable with “AHL.” (See Page 11)
- High Alternator Temperature 225°F Adjustable with “AL1.” (See Page 12 Requires installation of MC-TS-A sensor)
- High Battery Temperature >125°F Adjustable with “B1L.” (See Page 12 Requires installation of MC-TS-B sensor)
- Alternator Failure (No voltage on stator if bdL is enabled)
- Regulator Overtemp Fixed 90°C

### Aux #1 Lamp

The MC-618 provides an Auxiliary Lamp circuit that's capable of providing a signal to a user supplied and installed audible or visual alert to indicate the following while the regulator is in operation:

- Small Engine Mode is activated
- Regulator is at full field

## Force to Float

The Force to Float option causes the regulator to jump to the Calculated Float stage. This is accomplished by shorting pin #15, the positive wire of the Battery Two Temp Sensor, to ground. This is most easily accomplished by putting an on/off (SPST) switch in-line between pins #14 and #15. The feature is effective when the regulator is in stages 3 (Bulk) to 10 (Calculated Float). The Battery Sense #2 sensor can be used in parallel with a switch by using multi-stack connectors.

To install a force to float switch:

**NOTE:** The Battery Temperature Sensor #2 cable can be used in conjunction with the force to float switch. To do this, replace the female terminal connectors on the cable with Multi-Stack Connectors (Ancor Part # 230612).

1. Install a standard ON/OFF switch in a convenient location.
  2. Run wires from the switch back to the positive and negative terminals of the Battery #2 Temperature Sensor terminals ( #14 and #15).
  3. Add appropriate connectors to the switched wires and connect to the positive and negative terminal connections.
- If feature is activated prior to the regulator turning on, then the regulator will start normally with the start delay and then ramp. As soon as it reaches the bulk stage #3, the regulator will “Jump” immediately to the Calculated Float stage #10.
  - If the feature is activated while in stages 3-7, the program jumps to the #8 Ramp to float stage.
  - If the feature is deactivated while in the Calculated Float stage #10 then the regulator will adhere to the rules for that stage, see “Calculated Float” on page 10.
  - The only way to return to bulk stage after leaving (or skipping) bulk stage is to power cycle the regulator.
  - If Force to Float is disengaged during ramp to float, the regulator will transition to fixed time float (Stage #9). If this occurs, toggling the force to float switch will allow the regulator to skip the fixed float time and jump directly to calculated float. Once force to float is disengaged the regulator will return to absorb voltage (Stage #5).

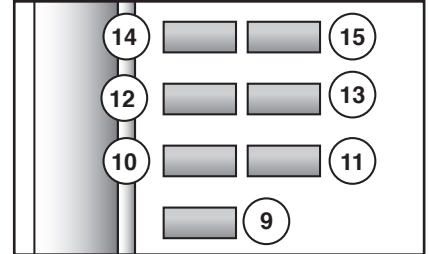

# System Troubleshooting

## What To Check First

The majority of charging difficulties can be attributed to damage, corrosion or wear at wiring, fusing or wiring connections. Before attempting to troubleshoot alternator or regulator issues, be sure to address the following:

1. Remove and clean all charging system electrical connections (positive and negative). Check the voltage regulator's harness for continuity. Wires and terminals can and will become corroded, and need to be cleaned or replaced. Ensure that the regulator's ground wires are provided with a clean connection to system ground.
2. Inspect and replace 10A and 1A ATC type fuses in the regulator wiring harness if fuse appear to be damaged or corroded. Ensure that the fuse holder is also free of corrosion.
3. Charge all batteries to their proper fully charged state, and determine if they are serviceable. If your batteries are flooded-type, use your hydrometer to determine their condition.
4. Check and tighten alternator belt. If the belt show signs of wear or damage, replace it. Always replace existing belts with the finest quality replacements available.

If batteries and wiring are in suitable condition, use the following tests to determine if charging problems are a result of a faulty alternator or regulator. These tests provide an opportunity to isolate the alternator, regulator and wiring harness in order to determine the problem source. In order to perform these tests, you will need an independent DC meter (preferably a digital type). In an emergency, a 12V light bulb or test light can be used to help determine if power or working grounds exist. An amp meter and a battery hydrometer with a thermometer are also helpful diagnostic tools.

## Voltage Regulator Testing

Set your voltmeter to 12VDC and connect the negative lead to the BLACK ground wire at the regulator as shown at the diagram at right.

1. With the ignition turned OFF, check voltage on the RED (power), Voltage Sense (Terminal #9), BLUE (field) and BROWN (Ignition) wires in the regulator plug.

Voltages should be as follow:

- RED wire equal to battery voltage
- Terminal #9 RED wire equal to battery voltage
- BLUE wire zero volts
- BROWN wire zero volts

2. With the ignition in the ON position (engine not running), check voltage on the RED (power), Secondary RED on Terminal #9 (voltage sense) BLUE (field) and BROWN (ignition) wires in the regulator plug:

- RED wire equal to battery voltage
- Terminal #9 RED wire equal to battery voltage
- BLUE wire between 4V and 11V
- BROWN wire equal to battery voltage

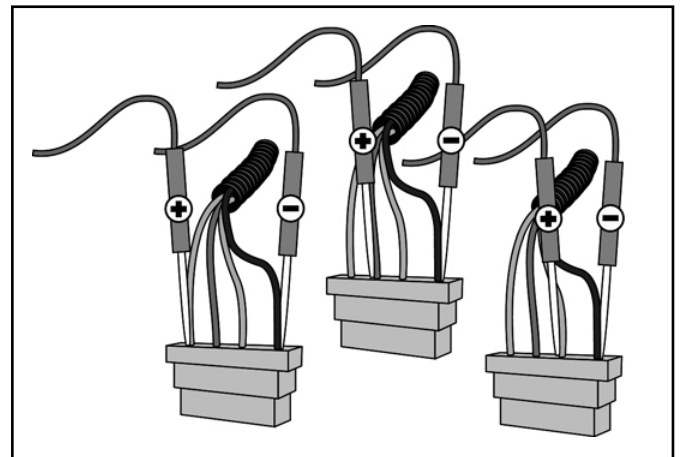

PLEASE NOTE: In systems where the ignition (BROWN) wire is supplied power via an oil pressure switch, jump directly from test #1 to test #3.

3. With the ignition in the ON position (with engine running at 1,400 rpm fast idle), check voltage on the RED (power), Secondary RED on Terminal #9 (voltage sense) BLUE (field) and BROWN (ignition) wires in the regulator plug. Voltages should be as follows:

- RED wire equal to battery voltage
- Terminal #9 RED wire equal to battery voltage
- BLUE wire between 4V and 11V
- BROWN wire equal to battery voltage

If voltage is not present on the RED, the BROWN and the Positive Battery Sense Wire, the regulator will not work. If voltage is as expected at the RED the BROWN and Positive Battery Sense wire, and there is zero, or an unexpected voltage reading at the BLUE wire, contact our technical support staff at +1(360) 435-6100, or e-mail us at [balmar@balmar.net](mailto:balmar@balmar.net).

If all voltages at the regulator meet expectations, yet the alternator is not producing charging current, test the alternator. The following tests are recommended for determining alternator functionality.

## Alternator Testing

TEST #1 - The following test is used to isolate the alternator and determine if the failure is a result of the alternator. Once again, testing at either the alternator or regulator is only effective if the wiring, fusing and batteries have been determined to be in correct working order. The alternator and regulator can be tested for function by determining if a magnetic field exists at the alternator's pulley shaft or rear bearing. To test:

1. With the ignition in the OFF position, place the tip of a non-magnetic steel screwdriver near the nut on the pulley shaft or near the rear bearing of the alternator. There should be no evidence of a magnetic field pulling the screwdriver toward the alternator. (A slight amount of magnetism may be present, due to residual voltage in the alternator).
2. Engage the ignition, without starting the engine, to activate the voltage regulator. If an oil pressure switch is used, a jumper between the RED and BROWN wires in the Ford-style plug will activate the regulator.
3. After allowing time for the regulator's start-up delay, place the head of a steel screwdriver near the nut on the pulley shaft or near the rear bearing of the alternator. There should be substantial magnetic pull. If a magnetic field is present, the voltage regulator, alternator brushes and rotor are likely to be working properly.

If there is little or no magnetic pull at the pulley shaft or at the rear bearing, initiate the following test:

With the key off and the engine off, remove the large harness plug from the regulator.

1. Insert the end of a short length of electrical wire to the RED connector slot of the regulator harness and the other end of the wire to the BLUE connector slot. This bypasses the regulator and tests the alternator and the harness.
2. Using your steel screwdriver, inspect for a magnetic field as described above.
3. With your voltmeter, check for voltage on the blue wire at the alternator. If voltage does not exist, the harness may be at fault. If voltage does exist at the harness, but no magnetism is present, the alternator is likely to be malfunctioning.
4. If a magnetic field is present. Both harness and alternator brushes and rotor appear to be working properly. If no magnetic field is present, proceed with the next test.

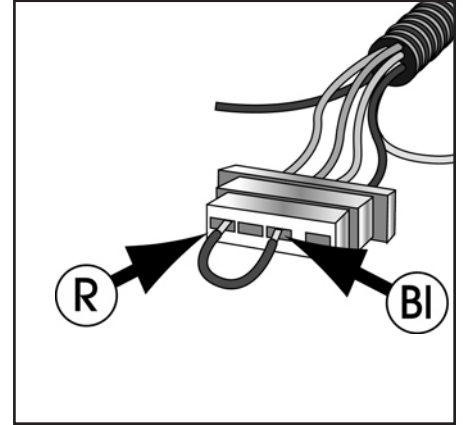

Testing the actual output of the alternator is known as "Full Field Testing". This can be accomplished by jumping a positive 12VDC current to the field terminal at the rear of the alternator. This test eliminates both the regulator and the harness, making it easier to isolate your investigation to the alternator.

**CAUTION:** Ensure that all voltage sensitive equipment is turned off prior to starting the engine. Voltage is unregulated during this test and could damage sensitive electronics. DO NOT let the engine run any longer than necessary to detect charging. If the system is not charging, remove the alternator and have it inspected by a qualified alternator shop, or call Balmar for warranty evaluation. To test the alternator:

1. Clip a jumper wire to the positive post of the alternator, or on the battery side of the isolator (if an isolator is in use). Use a SHIELDED alligator clip for post attachment. Unintentional contact between the alligator clip and the alternator case could result in damage to your electrical system.
2. Disconnect the field wire from the rear of the alternator and attach the other end of the jumper wire to the alternator's Field terminal (F). **CAUTION:** Do not allow the wire to contact the case while it is attached to the positive post. The case may be grounded and severe damage could occur.
2. The regulator is now bypassed. When the ignition is engaged and the motor is started, the voltage should rise and charging current should be present.
3. The motor should be run long enough to determine that charging voltage is present. Unregulated voltage can rise quickly. Do not allow extended unregulated charging to occur without carefully monitoring voltage levels. If the alternator fails to generate voltage during field testing, a malfunction of the alternator is likely. Contact your local alternator repair shop or Balmar's technical service staff for recommendations.

---

## Conclusion

If your readings differ substantially from the "expected Readings" listed in the troubleshooting charts, the regulator may be malfunctioning, or there may be a continuity problem. Contact our technical support staff at +1(360) 435-6100. If you determine that repair service is necessary for either your alternator or regulator, please gather the following information before contacting our service technicians: Make and model of alternator. Model of voltage regulator and date of mfg. (date punched on rear side label of regulator). Voltage readings on RED, BROWN and BLUE wire at regulator with engine off, key on. Voltage readings on RED, BROWN and BLUE wire at regulator with engine running at a fast ideal 1400rpm.

# Balmar Warranty

## Balmar Limited Warranty

Balmar's Limited Warranty covers defects in material or workmanship on new Balmar products generally for a period of (2) years from the purchase date. Only consumers or dealers purchasing Balmar products from authorized Balmar retailers or resellers and installed by a qualified installer may obtain coverage under Balmar's Limited Warranty. Components with a manufacturing date greater than ten (10) years old are not covered under the Balmar Warranty, even if the purchase date has been within the past two (2) years. Purchase from unauthorized resellers, which may include some online entities, may not guarantee the purchaser will receive a newly manufactured component, and therefore does not guarantee Warranty coverage.

## Warranty Resolution

If Balmar authorizes a product to be returned to Balmar or an authorized service provider, Balmar will repair the product or replace it without charge with a functionally equivalent replacement product. Balmar may replace the product with a product that was previously in service or repaired, but re-tested to meet Balmar specifications. Balmar will pay to ship the replacement product to the purchaser. By sending the product for replacement, ownership of the original product will be transferred to Balmar. Labor charges at the consumer's site are not covered under this Warranty. Balmar warrants that repaired or replaced products shall be covered under the Balmar Warranty for the remainder of the original product warranty, or 90 days, whichever is greater.

## Not Covered Under Warranty

Balmar's Warranty does not cover any problem that is caused by (a) an accident, abuse, neglect, exposure to shock, electrostatic discharge, heat or humidity beyond the product's specifications, improper installation, inappropriate operation/misapplication, maintenance or modification, or (b) any misuse contrary to the instructions provided with the product, or (c) loss, or (d) malfunctions caused by other equipment, or (e) acts of God. Examples of conditions not warranted: cracked or broken cases, parts damaged by fire, water, freezing, lightning, collision, theft, explosion, rust, corrosion, or items damaged in route to Balmar for repair. Balmar's Warranty is void if a product is returned with removed, damaged or tampered labels or any other alterations (including removal of any component or external cover) to the product. Balmar's Warranty does not cover labor charges or any direct, consequential, or incidental damages. Costs related to recovery removal or installation are not recoverable under the Balmar Limited Warranty.

## Applicable Laws

Balmar's Warranty is governed by the laws of the State of Alabama, USA. The Balmar Warranty provides the purchaser specific legal rights, and you may also have other rights that vary from state to state. Balmar's Warranty does not affect any additional rights consumers have under laws in their jurisdictions governing the sale of consumer goods, including, without limitation, national laws implementing EC Directive 44/99/EC. Some states do not allow the exclusion of limitation of incidental or consequential damages, so the limitation or exclusions of Balmar's Warranty may not apply in certain jurisdictions.

## Warranty Return Material Process

1. Contact Balmar Technical Support at +1 (360) 435-6100. Tech Support will review the troubleshooting steps with you to help determine if Balmar's product is defective.
2. Go to [www.balmar.net](http://www.balmar.net) and download the RMA request.
3. Once complete, you will receive an RMA number, at which point you should complete the forms and send them with the product and the original receipt showing the date of purchase to Balmar at the address listed below. Please include the RMA number on the outside of the package.
4. Please send the product postage prepaid via a carrier that can track the package. Note: If you have a 9-Series Alternator to return, please ship it to our Marysville, WA location.

**Balmar LLC**  
353 James Record Road SW  
Huntsville, AL 35824  
Attention: Warranty Returns RMA# \_\_\_\_\_

**Balmar LLC**  
15201 39th Ave. NE  
Marysville, WA 98271  
Attention: Warranty Returns RMA# \_\_\_\_\_

For more information, contact Balmar Customer Service or Technical Support at +1(360) 435-6100 or visit the Balmar website at [www.balmar.net](http://www.balmar.net). Balmar LLC believes all information herein to be factual and accurate, yet maintains no liability for factual or typographic error. In addition, Balmar retains the right to revise or update products without notification. Visit the Balmar website for product updates or bulletins and may apply to your alternator or voltage regulator. No part of this document may be reproduced without express written permission of Balmar LLC © Copyright 2022.



# BALMAR<sup>®</sup>

## DC CHARGING SOLUTIONS

*Balmar Knows How To Charge Your Batteries*



Balmar LLC  
15201 39th Avenue NE  
Marysville, WA 98271  
USA  
+1 (360) 435-6100  
www.balmar.net



CDI Electronics LLC  
353 James Record Road SW  
Huntsville, AL 35824  
USA  
+1 (256) 772-3829  
www.cdielelectronics.com



CDI Electronics designs and manufactures ignition components for outboard motors and diagnostic software for most Marine Engines. CDI enjoys relationships with 70 distribution partners around the world. To Find a CDI distribution partner, visit [www.cdielelectronics.com](http://www.cdielelectronics.com).

***Both Balmar and CDI Products are manufactured in our ISO 9000-Certified Factory in Huntsville, Alabama.***

Please read carefully. All policies, procedures and instructions are subject to change. This guide was prepared to provide information and does not constitute a contract. Balmar reserves the right, without prior notice, to change, delete, supplement, or otherwise amend at any time the information and policies contained in this guide.

For the most recent information about Balmar's products, policies and instructions please visit, [www.balmar.net](http://www.balmar.net).



Scan me

